

OWNER'S MANUAL

DIGITAL CONFERENCE SYSTEM



INDICE

1.	IMPORTANT SAFETY INSTRUCTIONS.....	3
2.	DESCRIPTION.....	5
3.	FRONT PANEL FUNCTIONS AND CONTROLS	5
4.	REAR PANEL FUNCTIONS AND CONTROLS	6
5.	CHAIRMAN AND DELEGATE UNIT FUNCTIONS AND CONTROLS.....	7
6.	CONNECTION AND INSTALLATION.....	8
7.	HOW TO USE THE SYSTEM.....	11
8.	FRONT PANEL FUNCTIONS AND CONTROLS	12
9.	R E A R P A N E L F U N C T I O N S A N D C O N T R O L S	132
10.	EXPANSION UNIT CONNECTION.....	13
11.	TECHNICAL FEATURES.....	15

1. IMPORTANT SAFETY INSTRUCTIONS



CAUTION: To reduce the risk of electric shock do not remove cover (or back panel). No user serviceable parts inside. Refer servicing to qualified personnel only.

WARNING: To reduce the risk of fire or electric shock, do not expose this apparatus to rain or moisture.



This symbol is intended to alert the user of the presence of uninsulated dangerous voltage within the product enclosure that may be of sufficient magnitude to constitute a risk of electric shock to persons.



This symbol is intended to alert the user of the presence of important operating and maintenance (servicing) instruction in the literature accompanying the appliance. Please carefully read the owner's manual.

INSTRUCTIONS:

All safety and operating instructions should be read before the product is operated.

Retain these instructions:

All safety and operating instructions should be retained for future reference. This owner's manual should be considered as a part of the product, it must accompany it at all times, and it needs to be delivered to the new user when this product is sold. In this way the new owner will be aware of all the installation, operating and safety instructions.

Heed all warnings:

All warnings on the product and in owner's manual should be adhered to. Heed all warnings.

Follow all instructions:

All operating and user's instructions must be followed.

Sentences preceded by  symbol contain important safety instruction. Please read it carefully.

DETAILED SAFETY INSTRUCTIONS.

Water and moisture:

This apparatus should not be used near water (i.e. bathtub, kitchen sink, swimming pools, etc.)

Ventilation:

This apparatus should be placed in a position that doesn't interfere with its correct ventilation. This unit, for example, should not be placed on a bed, sofa cover or similar surfaces that could cover ventilation openings, or placed in a built-in installation, such a bookcase or a cabinet that could block air flow through ventilation openings.

Heat:

This apparatus should be placed away from sources of heat, like radiators, heat registers, stoves or other products (including amplifiers) that produce heat.

Power sources:

- This apparatus should only be connected to a power source of type specified in this owner's manual or on the unit.
- If the supplied AC power cable plug is different from wall socket, please contact an electrician to change the AC power plug.
-

Grounding or Polarization:

- All precautions must be observed in order to avoid defeating grounding or polarization.
- Unit metal parts are grounded through the AC power cord.
- If the AC power outlet doesn't have grounding, consult an electrician for outlet grounding.

Power cable protection:

The power cable should be routed in such a way that it will not be walked on or pinched by items placed upon or against it, paying particular attention to cables at their connections, receptacles and wall outlet.

Cleaning:

- You can clean the exterior of the unit with compressed air or a damp cloth.
- Don't clean the unit using solvents like trichloroethylene, thinners, alcohol, or other volatile or flammable fluids.

Non use periods:

The unit AC power cable should be unplugged from the outlet if it's unused for long periods.

Objects or liquid entry into the unit:

Be careful that no objects fall into the unit or that no liquid is spilled inside the unit through ventilation openings.

Safe power line use:

- Hold the plug and the wall outlet firmly while disconnecting the unit from AC power.
- When the unit will not be used for a long period of time, please unplug the power cord from AC power outlet.
- To avoid power cable damage, don't strain the AC power cable and don't bundle it.
- In order to avoid damage to the unit's power cable, be sure that the power cable is not walked on or pinched by heavy objects.

Unit relocation:

Before relocating the unit, please control the unit is turned off. The power cord must be unplugged from the wall outlet, and all the connecting cables should be disconnected as well.

Do not open this unit:

Do not attempt to open or repair this unit yourself. For any problem not described in this owner's manual, please refer to qualified personnel only or consult us or your National Distributor. Any improper operation could result in fire or electric shock.



Damages requiring services:

- Do not attempt to perform operations not described in this user's manual.
- In the following cases please refer to an authorized service center or skilled personnel:
 - When the unit works improperly or it doesn't work at all.
 - If power cord or plug is damaged.
 - If liquid has spilled, or objects have fallen into the unit.
 - The unit has been exposed to rain.
 - The unit doesn't operate normally or exhibits a marked change in performance.
 - If the product has been dropped or has been damaged in any way.

Maintenance:

The user shouldn't attempt maintenance not described in this user's manual. All maintenance should be performed by qualified personnel only.

IMPORTANT SAFETY INSTRUCTIONS:

- Install this unit following owner's manual instructions.
- Do not install, connect or disconnect power supply when the unit is powered, otherwise there is a high risk of electric shock.
- Do not open the unit, there are no user serviceable parts inside.
- If you detect a particular smell from the unit, please immediately turn it off and disconnect the AC power cord.
- Don't block the unit's ventilation openings.
- Avoid using this unit in overload for a long period.
- Don't force commands (switches, controls, etc.)
- To obtain good speaker wire contact, please tighten the screw terminals firmly.
-  For safety reasons, do not defeat the grounding connection. Grounding is for user safety.
- Use only connectors and accessories suggested by the manufacturer. .
- This unit should be fitted in an equipment rack (see INSTALLATION) and kept far from:
 - Wet places
 - Direct exposure to heat sources (like sun light)
 - Improperly ventilated places
- Disconnect the power cord during storms or when the unit is not in use.
-  In order to prevent fire and reduce risk of electric shock, it is necessary to keep the unit far from dripping water. Please don't put cups, vases or other object containing liquids over the unit. In case of interference from source signal, THD value will raise over 10%. Don't place this unit in a bookshelf or in other enclosed spaces.
- We are not responsible for any damage that occurs due to a incorrect installation of the unit.

Thank you for choosing this product and for trusting our brand, which strives to be synonymous with professionalism, precision, high quality and reliability. All of our products comply with EC regulations regarding audio equipment for continuous use.

2. DESCRIPTION

This conference system uses digital technologies according to the European Community's IEC914 and ISO standards.

It is composed of a main unit and two microphone units – Delegate and Chairman – that feature high sensitivity, a wide frequency response, an internal loudspeaker and a cardioid electret microphone with a lighted ring for the visual identification of the microphone in use. The system is precabled to ensure fast and easy installation.

The device may include up to 64 microphone units, daisy-chained on four independent lines (or a maximum of 30 units on each line).

The system involves the use of several expansion units. Every expansion unit can support up to 60 units divided on six lines (never use more than 30 units on each line).

Adding four expansion units, the system can control up to 254 units.

The serial connection of each unit is achieved through single multicore, prerouted cables that may be used either for fixed or mobile systems.

Main Functions:

- It directly powers and controls 64 microphone units.
- Chairman unit has priority on others.
- Three operating modes: FREE MODE, LIMIT MODE and FIFO MODE
- Microphone sensitivity level control.
- Built-in video processor to support video camera tracking

Product complies with CE regulations

3. FRONT PANEL FUNCTIONS AND CONTROLS

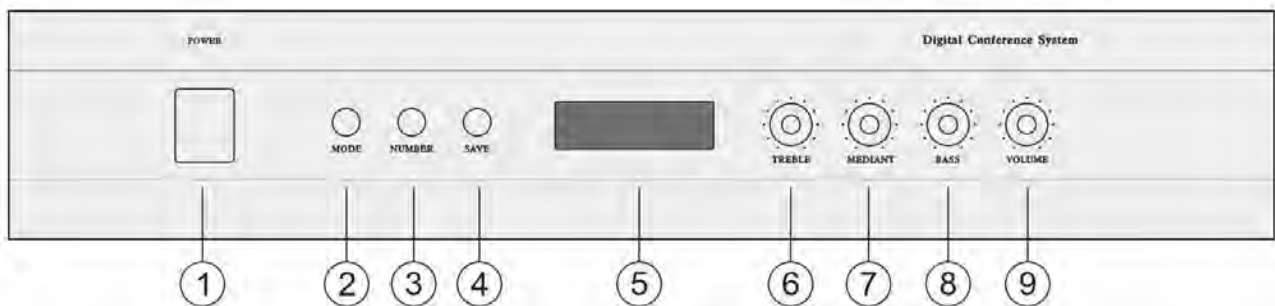

1. POWER

Main power switch

2. MODE

Allows selection of one of the following modes:

FREE MODE, LIMIT MODE, FIFO MODE, C.ONLY MODE and A.OFF MODE

3. NUMBER

When LIMIT MODE or FIFO MODE are selected, it allows the user to limit the number of simultaneous speakers taking part in the conference in addition to the Chairman. Set a value between 1 and 9

4. SAVE

Enables all selected settings

5. DISPLAY

6. TREBLE

Sets the treble level of external speaker

7. MEDIANT

Sets the mediant level of external speaker

8. BASS

Sets the bass level of external speaker

9. VOL

Sets the system amplifier audio level of external speaker

4. REAR PANEL FUNCTIONS AND CONTROLS

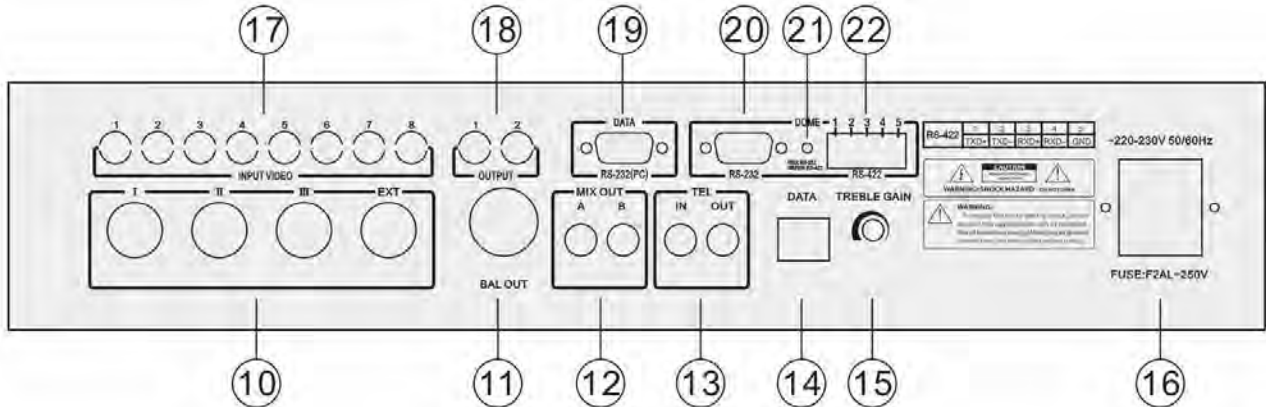

10. DELEGATES

N° 4 input per Chairman/Delegate unit. Up to 30 units can be connected to each line (do not exceed this quantity), or up to 64 units total

11. BAL OUT

Balanced signal output (male XLR3). Connect mixer or amplifier to this output

12. MIX OUT

Unbalanced signal output (RCA) Left and right channel

13. TEL IN/OUT

Connect telephone coincidence to support telephone meeting.

14. DATA

- a. Connect to this socket a central control system
- b. Connect to this socket from PC via USB-NET convertor for software management.

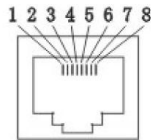

RJ-45

- | | |
|-------------|--------|
| 1- GND | 5- NC |
| 2- GND | 6- NC |
| 3- RS-485A+ | 7- GND |
| 4- RS-485B- | 8- GND |

15. TREBLE GAIN

Rotate this control counterclockwise to emphasize high frequencies

16. AC POWER SOCKET

Power 230VAC 50/60Hz

17. VIDEO CAMERA INPUTS

Connect these inputs to your camera. Up to 8 cameras max

18. VIDEO OUTPUT

Use this output to display camera video on an external video screen.

19. PC CONNECTOR

Connect this socket to your computer to setup the software function.

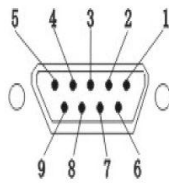

RS-232 (PC) female

- | | |
|--------|-------|
| 1- NC | 6- NC |
| 2- TXD | 7- NC |
| 3- RXD | 8- NC |
| 4- NC | 9- NC |
| 5- GND | |

20-22. CAMERA CONTROL CONNECTOR RS-422

If you use dome in place of camera you can control pan and tilt move directly from software. Connect this socket to the control connector of domes..

Note : To know connections, read the user manual of the dome.

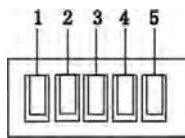

RS-422 (Green LED)

- 1- TXD +
- 2- TXD -
- 3- RXD +
- 4- RXD -
- 5- GND

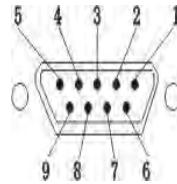

RS-232 Male (Red LED)

- 1.NC
- 2.TXD
- 3.RXD
- 4.NC
- 5.GND
- 6.NC
- 7.NC
- 8.NC
- 9.NC

5. CHAIRMAN AND DELEGATE UNIT FUNCTIONS AND CONTROLS

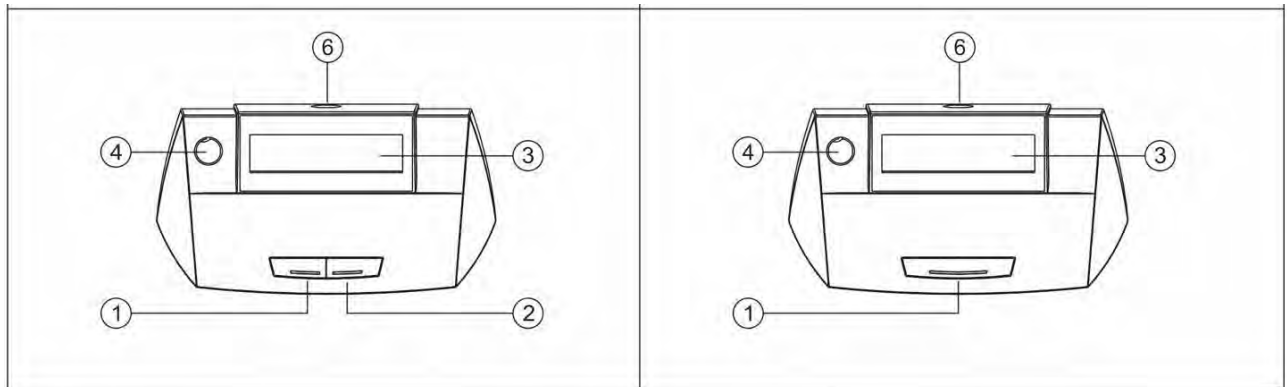
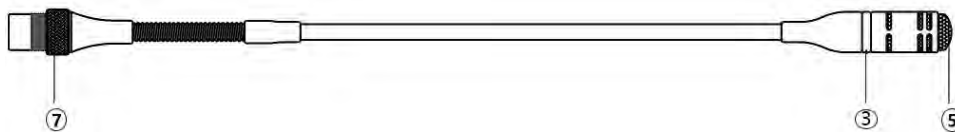

1. Microphone on/off key: Press this key to speak (the unit will be immediately enabled unless the limit of simultaneously enabled units has been reached), press again to turn off microphone
2. Priority key (for chairman unit only): When press and hold this key 1 second on chairman
3. Indicator light on active microphone: When microphone is active, indicator light switches on
4. Socket to lock the gooseneck microphone (Female)
5. Electret condenser cardioid microphone
6. 8P-DIN (female) socket to connect the system branch cable
microphone unit, all active delegate microphones will be switched off.
7. Microphone socket to fix he gooseneck microphone

6. INSTALLATION AND CONNECTION

Connect the unit to 230 V AC 50/60 Hz mains. Use the connection cables provided to connect the daisy-chained microphone units to the 4 **Delegates outputs**, paying attention not to connect more than 30 microphone units to each line and no more than 64 microphone units altogether.

The configuration cannot allow more than 30 microphone units on each loop.

In any case, the maximum limit of 64 microphone units cannot be exceeded.

The system can host more than one Chairman microphone. They can be inserted at any position on the chain.

- ① - Prepare conference controller, chairman microphone, delegate microphone, main extension cable and microphone branch cable (Y type)
- The controller is supplied with a main extension cable (13 m with one male DIN-8 connector for connection to the controller, one female DIN-8 connector for connection to the microphone Y type branch cable), one male-female XLR cable, one RCA-6.3 mm jack audio cable and one power cable

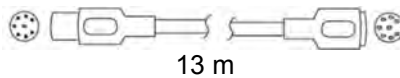

- Chairman microphone and delegate microphone are supplied with a branch/interconnection Y type cable (2+1.5 meters) with one female DIN-8 connector for connection to the main extension cable or to the previous microphone, 2 male DIN-8 connector for connection to microphone and extend the line to the next microphone

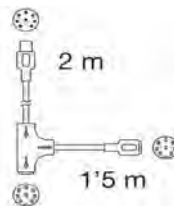

- ② Connect the main extension cable (male DIN-8 13 m) to one of the sockets group (DELEGATES) of the controller. In each of the 4 lines you can connect 30 mics maximum. Connect the other end of the extension cable (female DIN-8 13 m) to Y type microphone branch cable (male DIN-8 2 m), connect the chairman or delegate microphone to the Y type microphone branch cable (male DIN-8 1.5 m), and the male DIN-8 connector to the next Y type microphone branch cable (female DIN-8 2m) to extend the microphones

Note: *Paying attention not to connect more than 30 microphones units to each line and no more than 64 microphone units altogether, microphone quantity in one system may decreased according to different microphone type and cable length.*

- ③ If desired, contact any of the line-level outputs (balanced XLR or unbalanced RCA) to the input of an amplifier.
- ④ Connect the controller to 230 V AC 50/60 Hz mains by power cable.
- ⑤ To talk on a microphone, please press the on/off key. When you finish talking, turn off the microphone by pressing the key again. If microphone is active, indicator light switches on.
- ⑥ When chairman press and hold the PRIOR key 1 second on chairman microphone unit, all active delegate microphones will be switched off and the chairman microphone will active.

For discuss function

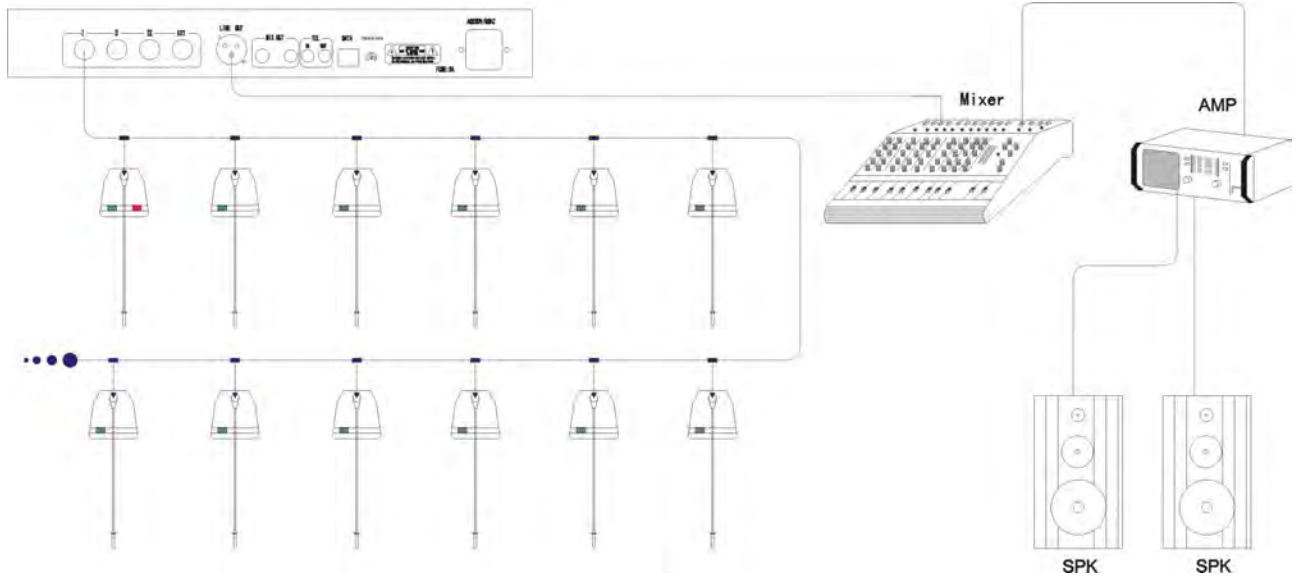

For discuss & Video tracking function

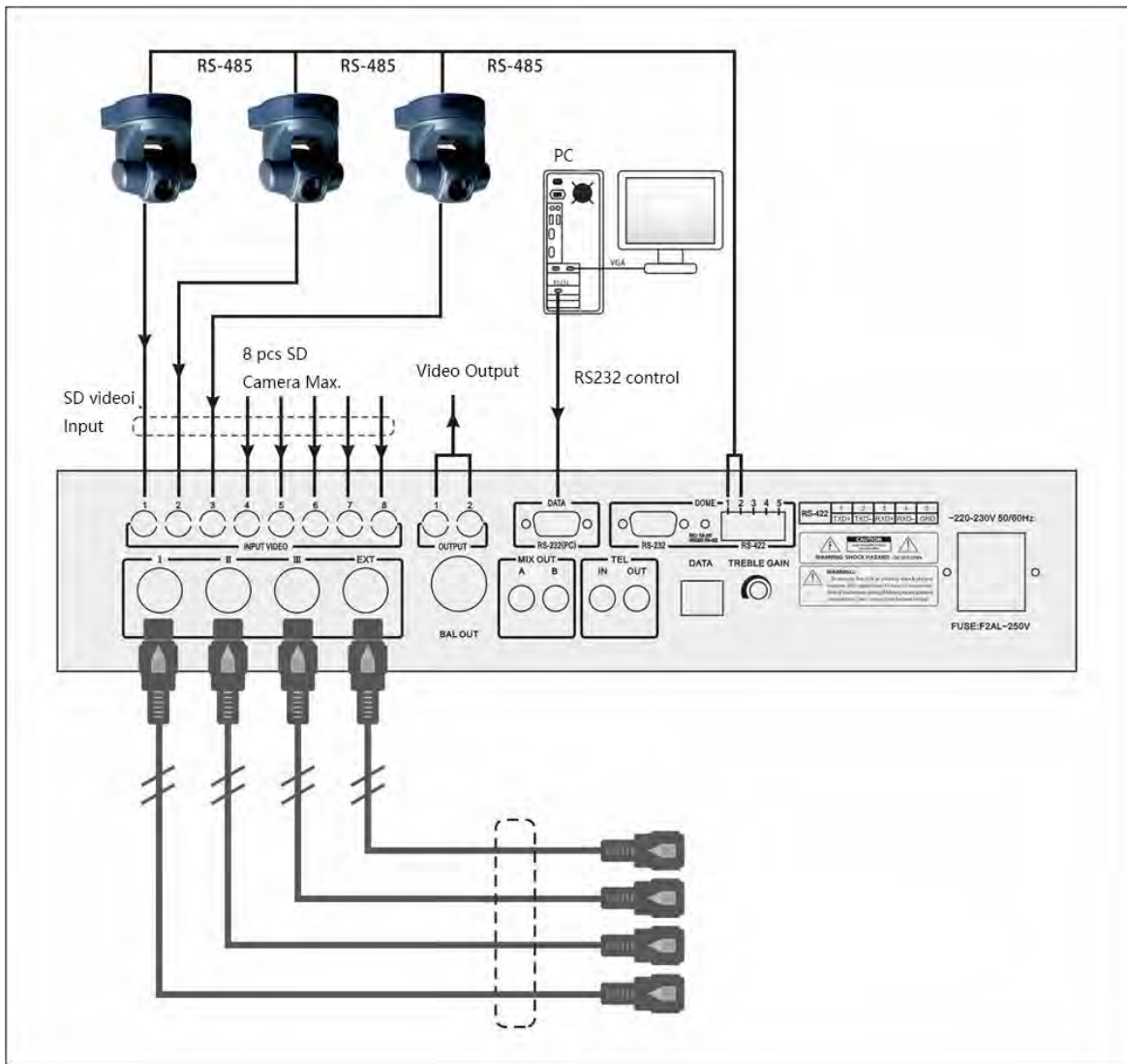

TYPE OF CONNECTIONS

Balanced connection:

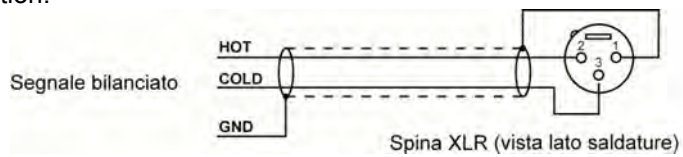

Unbalanced connection:

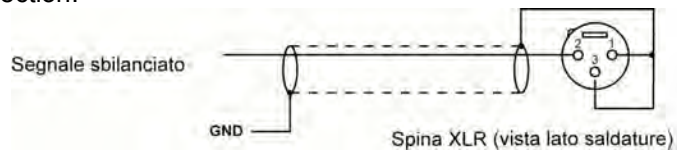

Balanced connection with TRS jack

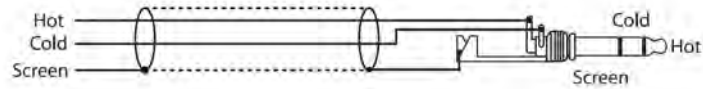

Unbalanced connection with TRS jack

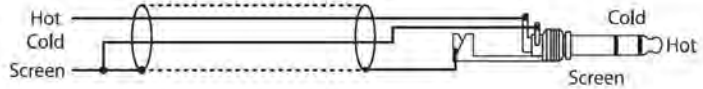

Balanced connection on EUROBLOC connector

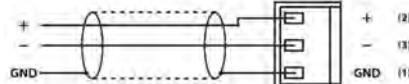

Unbalanced connection on EUROBLOC connector

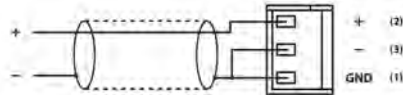

RCA Connection

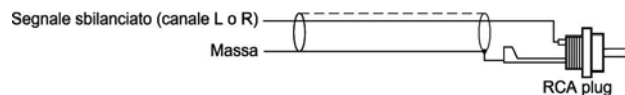

7. HOW TO USE THE SYSTEM

Turn on controller, the controller LCD will display current working mode

MODES OF OPERATION:

- FREE MODE**
 When this mode is selected, the display will read FREE MODE. In this mode, an unlimited number of participants can speak simultaneously.
- LIMIT MODE**
 When this mode is selected, this display will show LIMIT MODE, plus the number of delegates that can speak simultaneously. Once this number of delegates is reached, no further delegates will be allowed to intervene until the number of active delegate units again falls below this limit.
- FIFO MODE**
 When this mode is selected, the display will read FIFO MODE (First In-First Out), plus the number of delegates who can speak simultaneously. In this mode, the controller keeps track of the order in which the delegate units are activated. Once the preset limit of simultaneous delegates has been reached, and a new delegate presses the **MIC ON/OFF** key on his microphone base, the **FIRST** delegate unit that was active when this limit was reached will be made inactive, and the new delegate unit will be activated.

Activation and Deactivation of previous Operating Modes

Using the **MODE** button, select the desired operating mode and press **SAVE**. If the mode requires a numeric limit of delegates, this can be selected pressing the **NUMBER** button and pressing **SAVE** to complete the setup.

FUNCTIONS:

- **C. ONLY MODE**

When this function is activated, the display will show "C.ONLY MODE" followed by the check mark "√". When deactivated, the display will show "X" beside this function.

C.ONLY MODE √:

When the CHAIRMAN presses the **PRIORITY** key, all DELEGATES will be excluded, and the DELEGATE microphones will not reactivate when their **MIC ON/OFF** key is pressed. These will remain excluded until the CHAIRMAN again presses the **MIC ON/OFF** key.

C.ONLY MODE X:

When the CHAIRMAN presses the **PRIORITY** key, all DELEGATES will be excluded, but the DELEGATE microphones will be reactivated normally when their **MIC ON/OFF** keys are pushed.

In either case (C.ONLY MODE "√" or "X"), the number of DELEGATES who can speak simultaneously will be determined by the previously selected limit.

- **A. OFF MODE**

When this function is activated, the display will read A.OFF MODE followed by the check mark "√". When deactivated, the display will show "X" beside this function.

A.OFF MODE √:

All activated DELEGATE units will be automatically deactivated after 45 seconds of inactivity. In order to speak again the delegate will have to press MIC ON/OFF again

A.OFF MODE X:

There are no time limits for the activated DELEGATE bases

This function does not affect the CHAIRMAN unit

- **AUTO CODING**

Each mic has a number ID which is affected (very important to setup the auto-track and voting function)

Controller:

- The controller starts the setup of the mic code by turn on the controller+ hold and press **Number** button
- For that, use the buttons **MODE** and **Number** to select the start number, once the selected start number, press **SAVE** button, operator can start coding, usually system setup the code from 1
- In general, you assign number 1 to the chairman mic.
- The first setting code will transmitted to all the delegate mic.

Microphone:

- This coding information is displayed on all the microphone LCD, press the on/off button of the corresponding mic to the affected the number.
- The other mics are always show the coding information but with an incremented number of a unit.
- All mic LED will start flash during setup code, the LED will off after setup code.
- Please restart the system to save the system code setup of mic

Activation/Deactivation of functions

Select a function using the scroll button **MODE** and activate/disactivate pressing the **NUMBER** button

8. FRONT PANEL FUNCTIONS AND CONTROLS OF EXPANDER



1. **POWER**
Main power switch

9. REAR PANEL FUNCTIONS AND CONTROLS OF EXPANDER

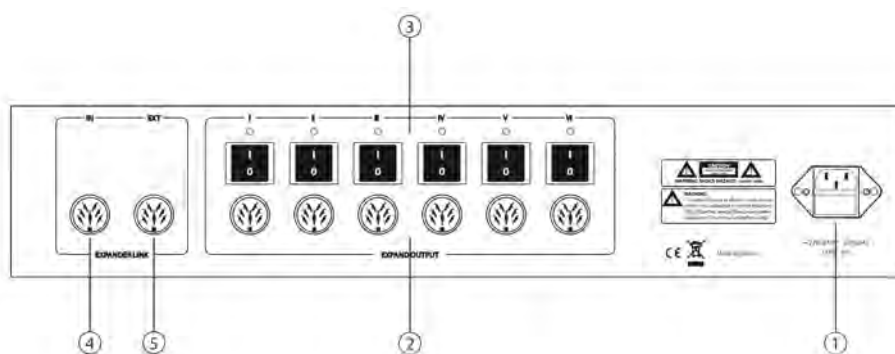

1. **MAINS POWER INPUT**
Connect main unit to **230 V AC 50/60 Hz** mains.
8 A fuse socket.
2. **EXPANDER OUTPUT**
6 inputs for Chairman/Delegate units. Each line can be connected to up to 30 units (do not connect more than 30). One EXSPANDER can manage up to **60** units.
3. **In-line Power Switches**
After connecting the units to the system, set the switches of the lines involved on the "1" position. The LED light will indicate that the line is powered.
4. **EXPANDER LINK IN**
Connect this input to one of the 4 DELEGATE outputs using the cable provided
5. **EXPANDER LINK OUT**
Connect this output to the next expansion unit input using the provided cable. There is no limit to the number of expansion units that can be connected, yet the total number of manageable microphone units must not exceed 254.

10. EXPANSION UNIT CONNECTION

Method 1:

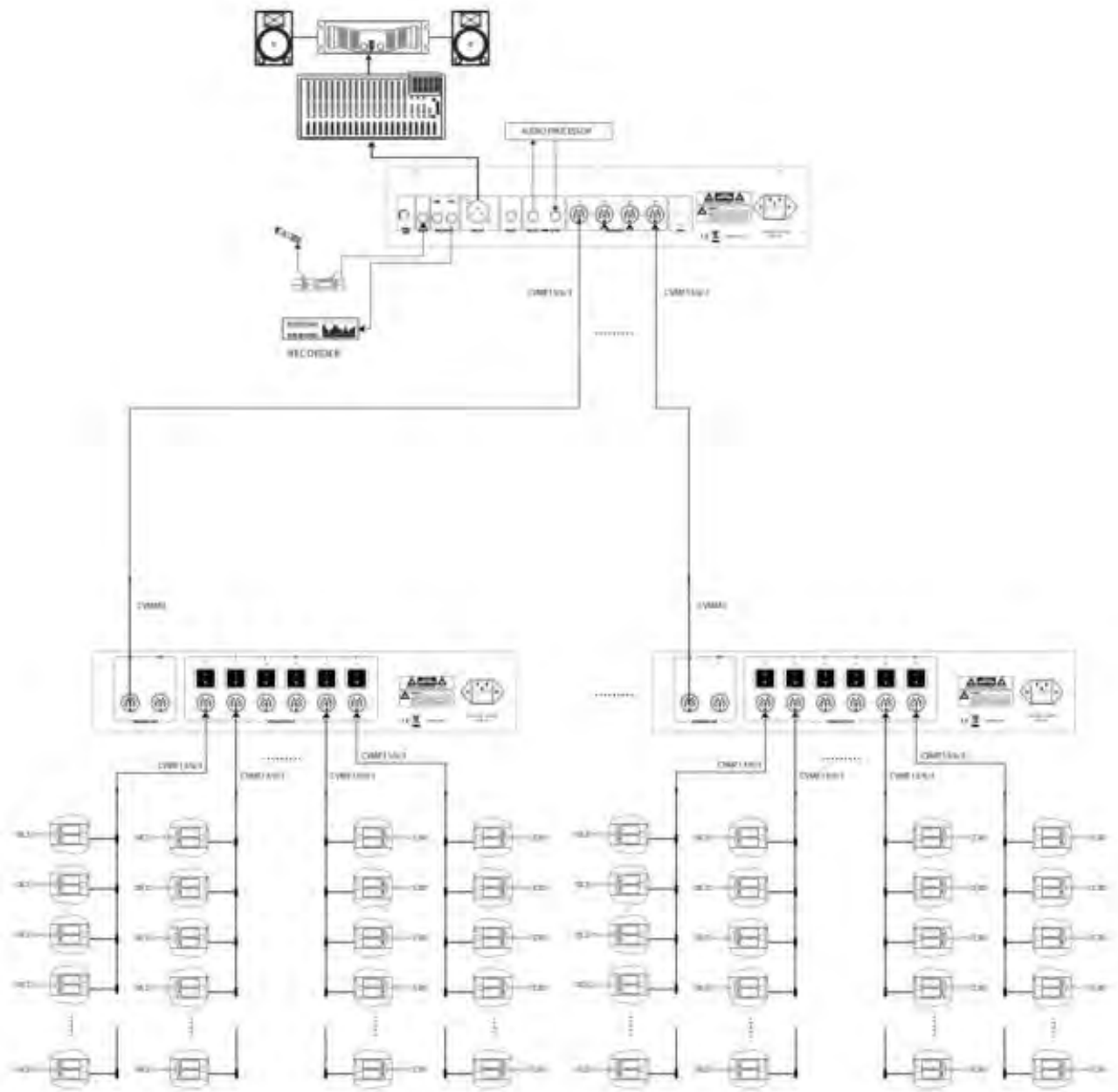

Note:

Be sure to keep the shortest possible distance between the central unit and the last microphone. For long distances we advise opting for method 1.

Method 2:

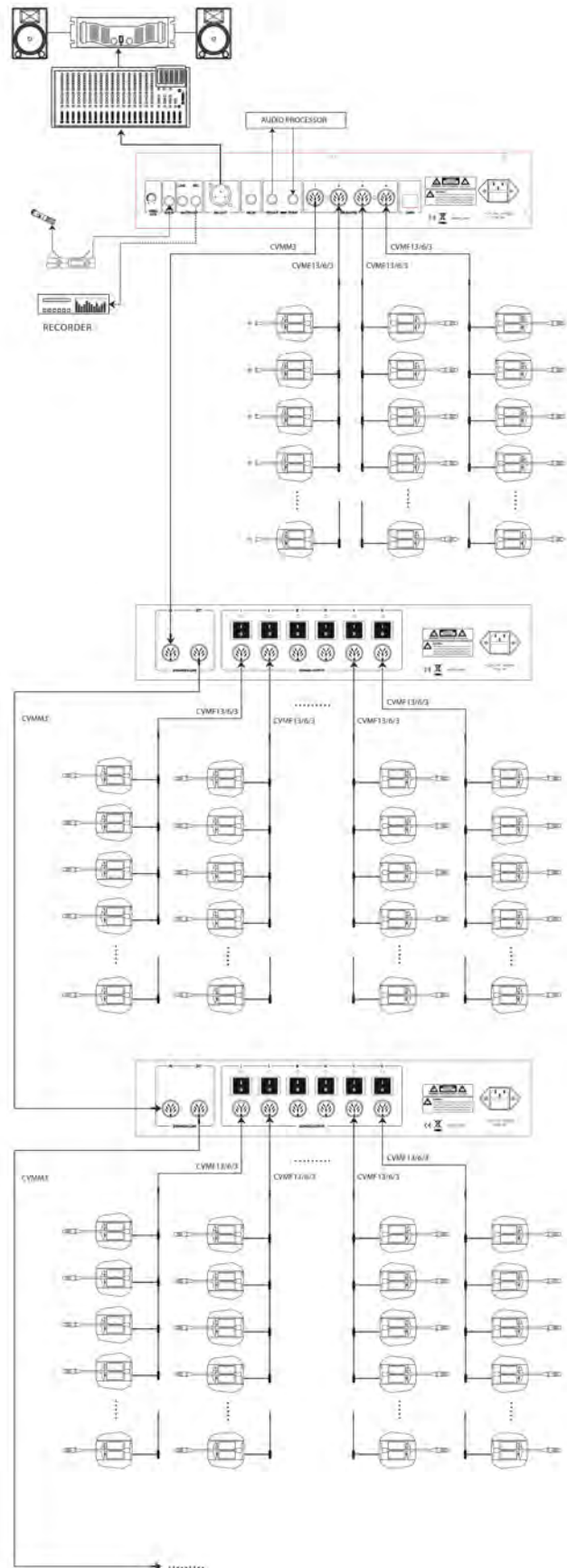

11. TECHNICAL FEATURES

CONFERENCE CONTROLLER	
Installation	Desktop or 19" rack
Dimensions (mm)	485×100×355 (W×H×D)
Weight	11.8kg
Frequency Response	100Hz - 18KHz
S/N ratio	>96dB
T.H.D	0.1% @1kHz
Power supply	230 V AC 50/60 Hz
Audio Output	BAL OUT (BAL)
	MIX OUT A(UNBAL)
	MIX OUT B(UNBAL)
TEL Coincidence Connection	TEL IN(UNBAL)
	TEL OUT(UNBAL)
Output Load	>1 kΩ
Control Interface	RJ45
Power Consumption	115W
PC Control	RS-232 (PC)
Video Input/Output	8 xInputs, 2 xoutputs (RCA)
Camera Control	RS232/RS422/RS485



This product complies with Directive 89/336/EEC (Electromagnetic Compatibility) and later changes 92/31/EEC and 93/68/EEC, according to the following standards:
EN 50082-1:1997, EN 55013:1990, EN 55020:1994

furthermore, it complies with Directive 73/23/EEC (Low Voltage) and later changes 93/68/CEE, according to the following standard:
EN 60065:1998

We maintain a policy of constant research and development, therefore we reserve the right to apply improvements to existing equipment without prior notice.